

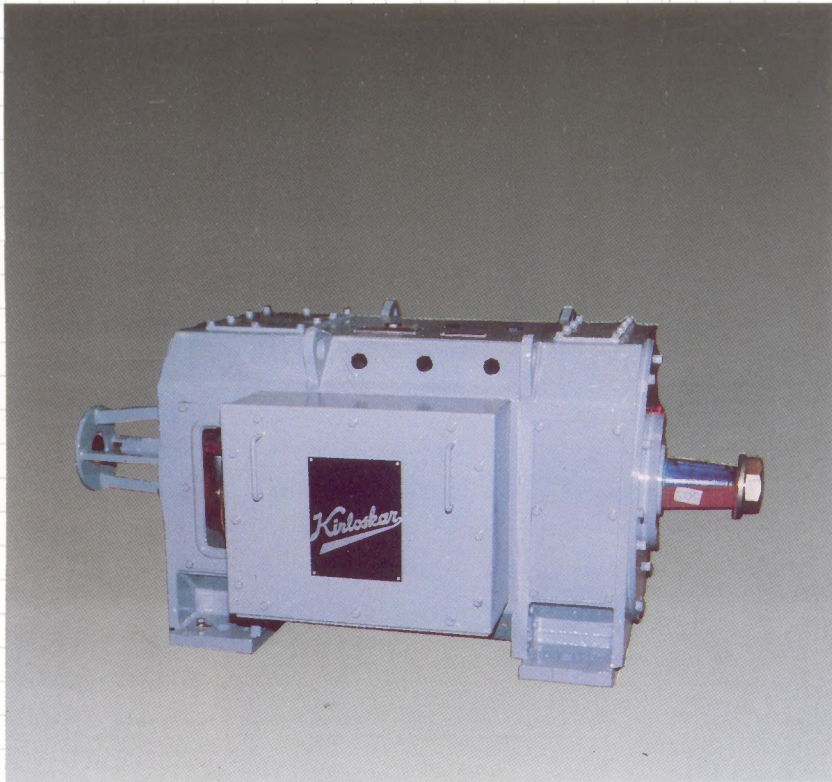

**AUXILIARY MILL DUTY  
DC MOTORS**



**KIRLOSKAR ELECTRIC**



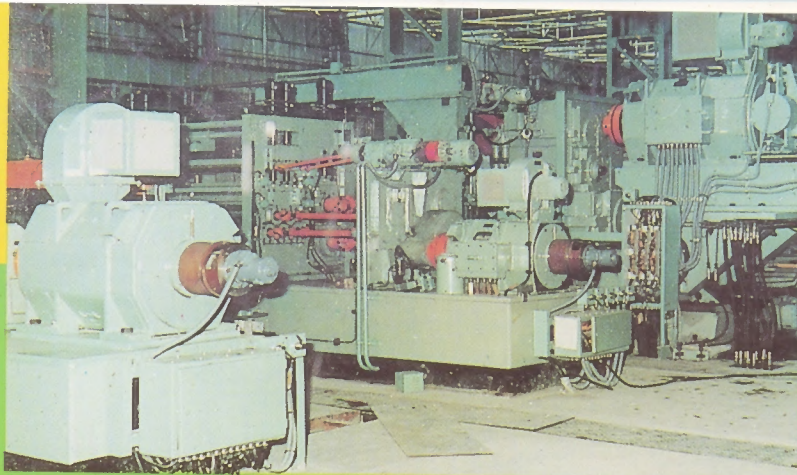

**K**irloskar Electric is a part of the century old Kirloskar group of industries manufacturing diversified products like electrical machines, machine tools, internal combustion engines, compressors, process control equipments, pumps etc., with a turnover of Rs.1250 crores and employing over 25000 people.

Kirloskar Electric manufactures the entire range of industrial electrics like DC Motors & Generators, AC Motors & Generators, Transformers, Motorised Gear Units, Industrial and Power Electronics and Computers.

The technological ability combined with a constant endeavour to produce quality electrical equipments have resulted in many mile stones and industrial developments.

Kirloskar Electric believes that the inherent strength of its organisation lies in its human resources. From its experienced engineers to its highly skilled work force, the Kirloskar Electric team is bound together by a common thread of quality consciousness and customer satisfaction.

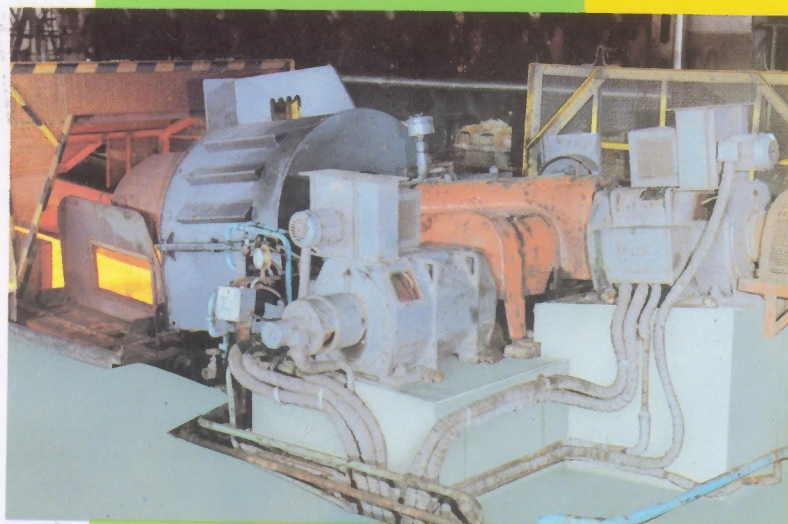

**K**irloskar Electric has a wide product range of DC Machines to suit specific applications.

The AISE auxiliary Mill Duty DC Machines are being manufactured for nearly 20 years and has proved its mettle in the arduous working environment. With a tradition of leadership, Kirloskar Electric is the only manufacturer in India and one among the few in the world to produce laminated yoke version of 800 series AISE DC Motors.

To suit specific application needs all motors from 802 through 824 in various constructions and designs are available.

Application support for special requirements is a unique strength of Kirloskar Electric.



## General

Kirloskar Electric 800 series Mill Duty DC Motors conform on rating, performance and dimension to AISE standard no. 1 revised 1968, recognised by users all over the world.

There is a choice of rigid, non-split, solid yoke frame construction, split solid yoke and non-split laminated yoke to suit the application requirement.

Compensation windings are provided on frames 814 and above in non-split solid construction and on all frames above 808 in non-split laminated yoke machines.

A wide variety of designs are offered to suit full speed, half speed and quarter speed requirements at preferred armature voltages of 230, 400 & 460 V. Class 'H' insulation is employed with temperature rise limited to 75° K by resistance method over an ambient of 40° C for force ventilated continuous duty motors. For TENV - 1 hr duty the temperature rise is limited to 110° K over 40° amb by resistance method. Field winding however can be continuously ON, even when non-ventilated. (Working altitude of ≤1000 m). High overload capability is commensurate with the application needs.

(Table 1)

Maximum armature voltage of upto 700V is possible on most of the armature designs. Higher voltages can also be given on request. Field winding is designed for 600V insulation class. With nominal voltage at 230V, field forcing would be possible to achieve momentary peak torque.

## Nomenclature

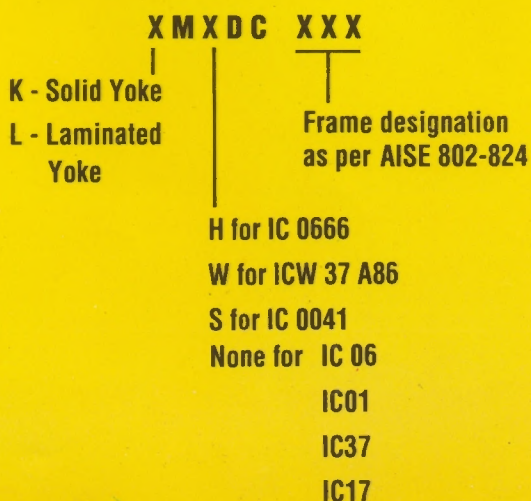

Table : 1

P.U. Torque	% rated speed	
	230V	460V
3.0	200	100
2.5	250	140
2.0	300	200

(Higher values on request)

The permissible stall currents are:

P.U. Current	Time (Sec)
3.0	15
2.5	20
2.0	30
1.0	60
0.5	300
0.25	Continuous

Applicable for force ventilated motors

## Unique Features

- di/dt of 250 In/Sec on laminated yoke machines & 60 In/sec on solid yoke machines (Higher values on request)
- Choice of cooling IC 06, IC 17, IC 37, IC 0041, IC 0666, ICW 37-A 86. (Modular construction)
- TIG-brazed armature coil joints on request to suit very high overload requirements
- Vacuum-pressure Impregnation for increased reliability
- Armature constructed on sleeve permitting easy shaft replacement
- High tensile, toughened shaft
- Infrastructure covering design, manufacture and testing



## Design



The electrical and mechanical designs are fully computerised. Optimisation of performance and reliability are ensured by analytical methods like the use of FEM technique. The selection of raw material is carefully done to achieve highest efficiency for the entire range of operation of speed, outputs and overloads.

## Magnet Frame

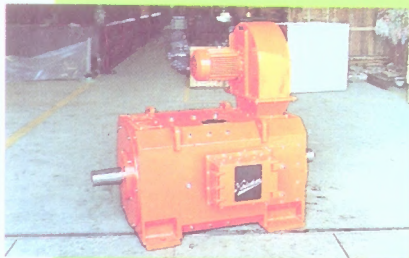

A choice of solid yoke split, un-compensated OR non-split, compensated OR laminated yoke compensated type of machines are available to the users, to suit specific requirements.

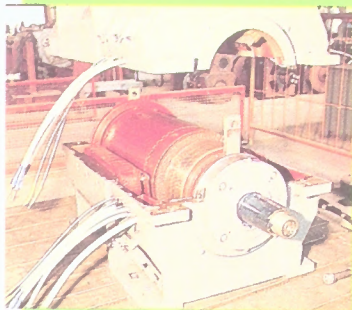

## Commutator

A special alloy is employed for the inhouse manufacture of Commutator ensuring proper dynamic seasoning and testing for the highest operating speeds. Computer aided design and availability of toolings for wide variety voltage - speed combination, results in quick deliveries and the highest quality standards.

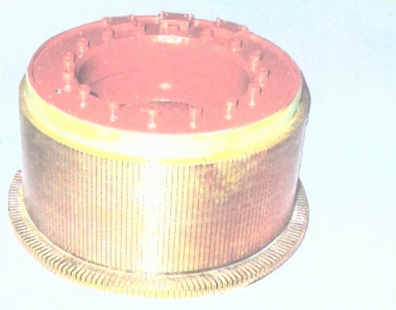

## Field Coil

Special care is taken to make the Field Coils compact and effective on heat transfer. The fixing up of coils of the pole bricks and the pole coil assembly to the stator ensures vibration-free performance for reliability.

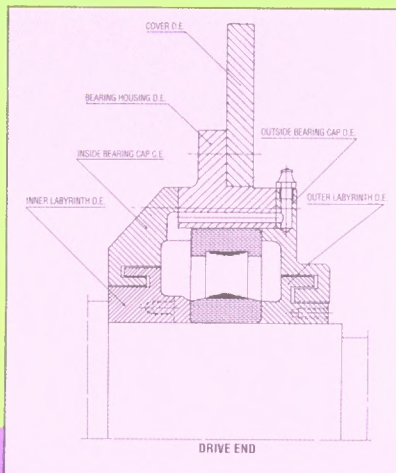
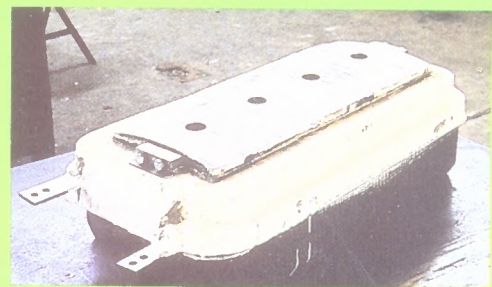

## Bearings

Anti friction bearings are used with careful selection made to suit the application needs. The lubrication for the bearings ensures satisfactory performance under the most arduous working condition. The design of the bearing assembly attempts a minimum of 20,000 hrs life for the specific application.



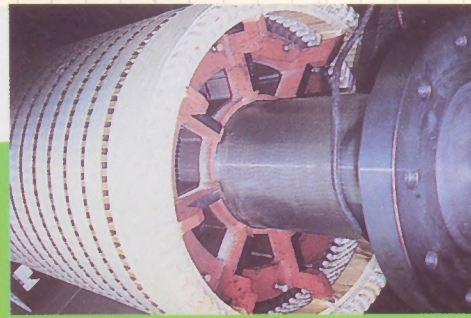
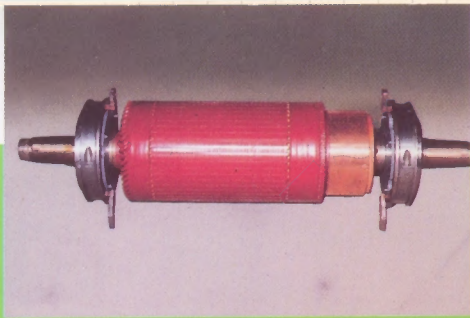

## Armature

Adequate precautions are taken in preparing the armature coils using automatic coil forming machine and insulating the same to the requirements under dust-free environment to provide the desired level of reliability.

Skilled technicians with continuous training are entrusted with the most critical operation of the DC Machine. The progress is verified at each step with stringent quality measures to prepare each armature for the ultimate duty class.

## Vacuum Pressure Impregnation

Carefully selected solventless resin employed for the vacuum pressure impregnation of armatures provides void-free treatment ensuring better heat transfer in addition to protecting the windings against influence of moisture, chemical fumes and other contaminations.



## TIG - Welding

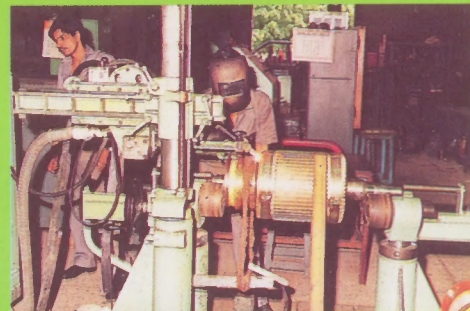

Choice of TIG-Welding joints for the armature coil to Commutator is available when very high currents are involved.

## Dynamic Balancing

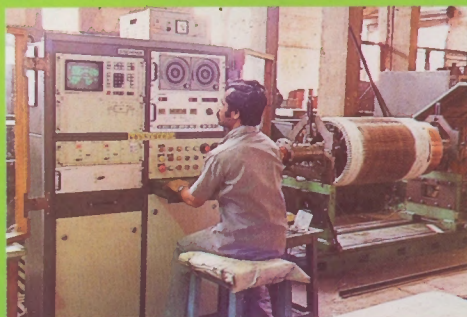

Armatures are dynamically balanced to precision grade to ensure low vibration operation.

## Testing

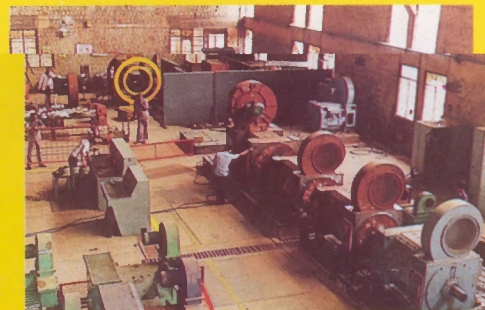

Thyristor converter source of supply is employed for testing all motors to ensure the satisfactory performance of the machine on both thermal levels and commutation; under influence of ripple content. Simulation of application conditions for acceleration, braking, reversals and starting can be demonstrated.



# Exploded view of Solid Yoke Split Mill Duty Motor

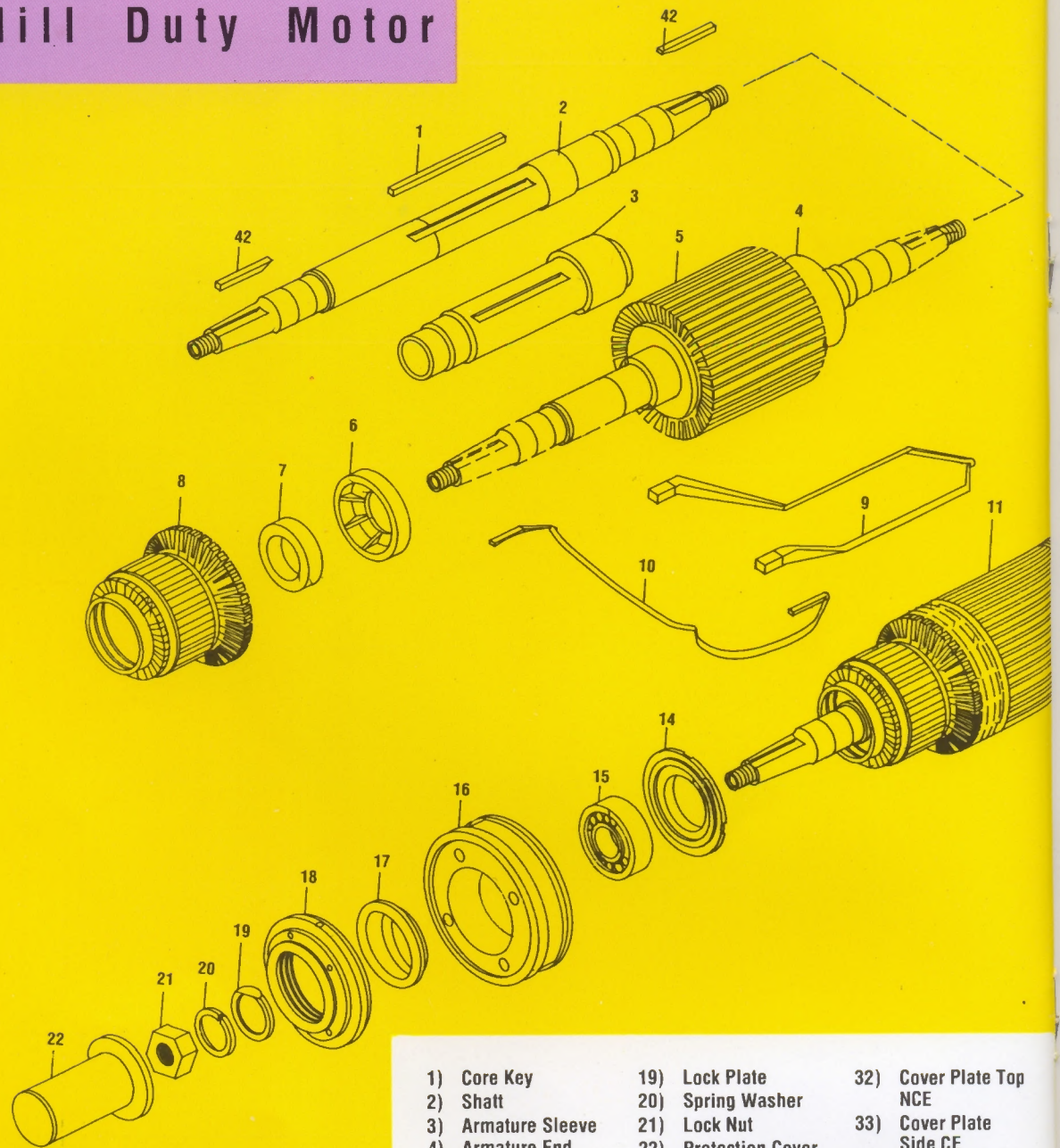

- |                          |                                       |  |
|--------------------------|---------------------------------------|--|
| 1) Core Key              | 19) Lock Plate                        | 32) Cover Plate Top NCE                        |
| 2) Shatt                 | 20) Spring Washer                     | 33) Cover Plate Side CE                        |
| 3) Armature Sleeve       | 21) Lock Nut                          | 34) Cover Plate Top CE                         |
| 4) Armature End Ring NCE | 22) Protection Cover                  | 35) M.P. Sub assembly (MP Coil and pole brick) |
| 5) Armature Core         | 23) Field Magnet Top Half             | 36) C.P. Sub assembly (CP Coil and pole brick) |
| 6) Armature End Ring CE  | 24) Field Magnet Bottom Half          | 37) Bush Rocker                                |
| 7) Forcing Collar        | 25) Hexagonal Hd. Bolt                | 38) Brush Spindle                              |
| 8) Commutator            | 26) Nut                               | 39) Brush Holder                               |
| 9) Armature Coil         | 27) Cover Plate NCE Side              | 40) Carbon Brush                               |
| 10) Equiliser Coil       | 28) Cover Plate Bottom NCE            | 41) Brush Holder Fixing Plate                  |
| 11) Wound Rotor          | 29) Cover Plate Side CE (Bottom half) | 42) Extension Key                              |
| 12) Hub Fan              | 30) Cover Plate NCE Side              |  |
| 13) Internal Fan         | 31) Cover Plate NCE Side              |  |
| 14) Inside Bearing Cap   |                                       |  |
| 15) Bearing              |                                       |  |
| 16) Bearing Housing      |                                       |  |
| 17) Labyrinth            |                                       |  |
| 18) Outside Bearing Cap  |                                       |  |



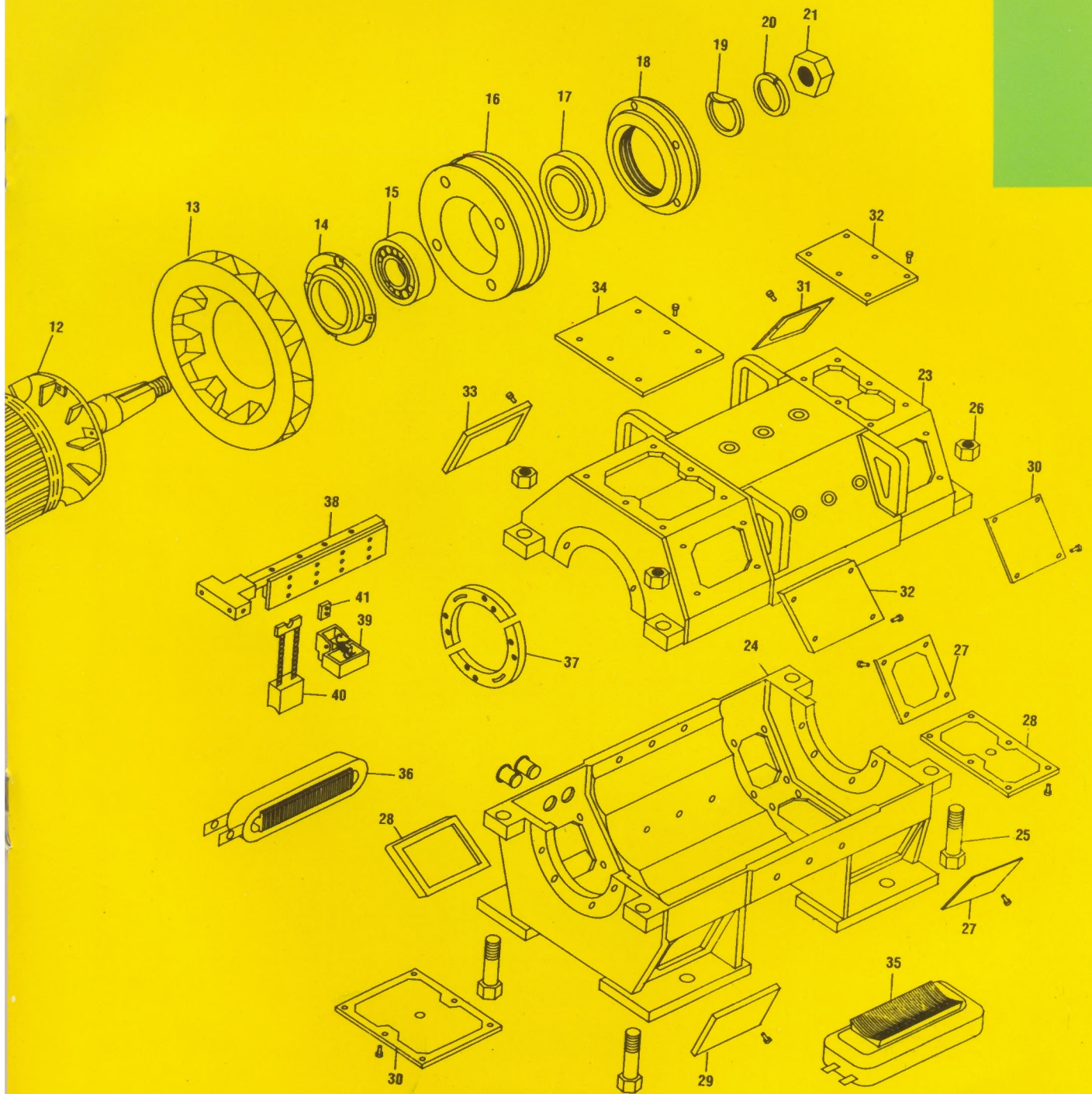



## Dimension details: Solid Yoke and Laminated Yoke Mill Duty Motors — Type KMDC / LMDC

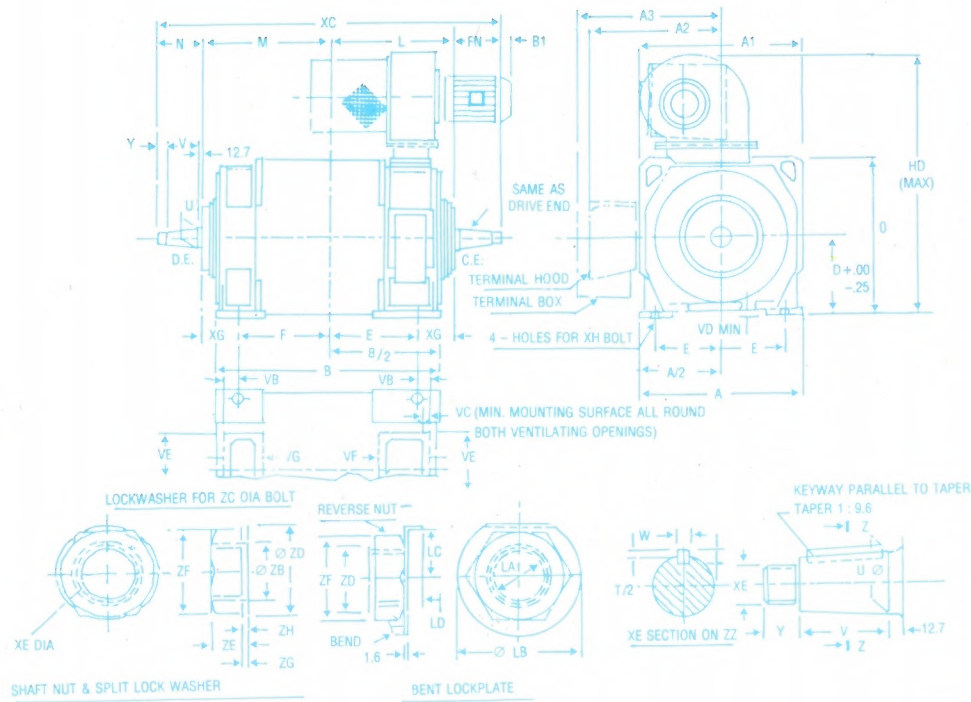

FRAME	SHAFT											KEY								
	A	B	XC	D	E	F	XG	H	XH	L/M	D	HD Max	N/FN	U	V	Y	XE	W	T	BEARING No.
802	381	520.7	835.02	193.68	158.75	209.55	95.25	24	M20	304.8	400	680	112.71	44.45	69.85	30.16	M30X2	12.7	12.7	NJ 310
803	431.8	596.9	839.8	215.9	177.8	228.6	114.3	28	M24	342.9	445	850	127	50.8	82.55	31.75	M30X3	12.7	12.7	NJ 311
804	457.2	647.7	990.6	228.6	190.5	241.3	127	28	M24	368.3	470	878	127	50.8	82.55	31.75	M36X3	12.7	12.7	NJ 313
806	508	698.5	1073.16	254	209.55	266.7	127	28	M24	393.7	521	929	142.38	63.5	95.25	34.93	M42X3	12.7	12.7	NJ 315
808	577.9	793.8	1206.5	285.75	238.13	314.32	130.17	35	M30	444.5	584	1056	158.75	76.2	107.95	38.1	M48X3	19.05	12.7	NJ 317
810	622.3	825.5	1206.5	317.15	267.35	330.2	146.05	35	M30	476.25	635	1108	167.93	82.55	107.95	41.28	M48X4	19.05	12.7	NJ 319
812	585.8	914.4	1397	339.73	285.75	361.95	158.75	35	M30	520.7	692	1164	177.8	92.075	120.65	44.45	M64X4	19.05	12.7	NJ 321
814	762	1054.1	1543.06	374.65	317.5	406.4	184.15	42	M36	590.55	762	1353	180.58	107.95	120.65	47.63	M80X4	25.4	19.05	NJ 324
816	825.5	1187.5	1714.5	406.4	342.9	444.5	215.9	42	M36	660.4	829	1411	196.85	117.475	133.35	50.8	M90X4	31.75	19.05	NJ 326
818	914.4	1263.7	1793.85	450.85	381	495.3	203.2	48	M42	698.5	918	1501	198.44	127	146.05	39.69	M100X4	31.75	25.4	NJ 328
620	1054.1	1320.8	1981.2	530.23	457.2	558.5	203.2	56	M48	782	1076	2150	225.6	149.225	165.1	30.8	M110X4	38.1	38.1	NJ 330

FRAME	LOCK NUT & SPLIT LOCK WASHER											VENT DUCT FLANGE SURFACE									
	LA	LB	LC	LD	A1	A2	A3	ZB	ZC	ZD	ZE	ZF	ZG	ZH	VB	VC	VD	VE	VF	VG	B1
802	31.5	63.5	25.4	6.4	378	370	289	35	36	56.2	22	48	6	4.5	22.2	9.5	9.5	184.2	120.7	55.6	4
803	37.5	73	28.5	8	422	400	310	41	42	68.2	24	55	7	5.5	44.5	12.7	9.5	215.9	127	82.55	55
804	37.5	73	28.5	8	448	420	324	41	42	68.2	24	55	7	5.5	57.2	12.7	9.5	228.5	139.7	69.9	48
806	43.5	92.1	31.8	14.3	500	465	450	47.5	28	75	27	65	7	5.5	54	12.7	9.5	260.4	152.4	85.7	24
808	48.5	109.5	38.1	16.7	582	495	481	51.5	52	83	30	75	8	6.5	50.8	12.7	19	292.1	165.1	88.9	13
810	57.5	120.7	41.3	19	612	535	506	59.5	60	91	32	85	8	6.5	54	12.7	19	304.8	177.8	92.1	—
812	65.5	127	47.6	15.9	670	570	570	71.5	72	103	36	95	8	6.5	63.5	15.9	19	349.3	209.6	123.8	—
814	81.5	149.3	56.3	18.3	740	610	610	89.5	90	121	40	115	8	6.5	85.7	15.9	19	387.3	235	139.7	29
816	91.5	165.5	65.7	15.9	800	700	700	99.5	100	131	32	130	8	6.5	114.3	25.4	19	406.4	279.4	183.3	—
818	101.5	171.5	66.7	19	890	760	745	109.5	110	141	40	145	8	6.5	98.4	25.4	19	457.2	304.8	181.0	—
620	—	—	—	—	1050	830	825	119.5	120	151	45	155	8	6.5	95.3	25.4	19	558.8	196.91	195	120

NOTE: DIMENSIONS FOR OTHER COOLING METHODS AND FOR FRAMES ABOVE 620 CAN BE FURNISHED ON REQUEST.



# Solid Yoke Motors Type: KMDC

TECHNICAL PARAMETERS OF MILL MOTORS FOR FULL, HALF AND QUARTER SPEEDS. ARMATURE REF: 1: FULLSPEED, 2: HALF SPEED; 3: QUARTER SPEED. DATA FOR SEPARATELY EXCITED SHUNT MACHINES ONLY. SOLID YOKE CONSTRUCTION FOR THE FRAME AND IC 17,37, IC 06 FOR ALL FRAMES AND IC 0666 AND W27A86 COOLING FOR FRAMES 808 AND ABOVE.

FOR FRAMES 814 TO 818 POLE FACE COMPENSATION ARE PROVIDED AND ARE AVAILABLE IN NON SPILT TYPE OF CONSTRUCTION ONLY. SPILT BUT UNCOMPENSATED CONSTRUCTION IS AVAILABLE ON REQUEST FROM FRAMES 814 TO 818.

FRAME	ARM REF	AIR QTY L/S	BASE SPEED RPM AT VOLTS			POWER KW AT			RATED TORQUE NM	RATED CURRENT AMPS	TORQUE MAX NM	CURRENT MAX AMPS	MAX COMM PRODUCT KA*RPM	MAX SPEED RPM	MAX VOL V	ARM CKT LmH R OHMS AT 115 DEG	EX CN SUPPLY KW APPROX	INERTIA 2 GD	MECH TIME CONSTANT	ARM WEIGHT TOTAL WT.
			230	400	460	230	400	460												
802	1	75	900	1630	1885	7.5	13.5	15.5	79	39.0	240	136	150	500	9.2		1.2	118		
		112				8.0	15.5	17.5	90	44.0										
	2	75	405	770	900	3.4	6.0	7.6	78	18.8	235	66	38	3600	500	37	0.25	1.2	54	74
		112				3.9	7.0	8.5	90	21.5										
	3	75	160	340	405	1.3	2.8	3.3	78	9.5	235	33	7.5	500	186			1.2	21.4	275
		112	150	330	395	1.4	3.1	3.7	90	10.2										
803	1	95	800	1440	1670	11.0	20.0	23.0	131	55.0	395	192	225	500	7.2		2.1	111		
		142				12.5	23.0	26.5	151	62.5										
	2	95	365	685	800	5.0	9.5	11.0	131	27.0	395	94	56	3300	500	29	0.3	2.1	51	115
		142				5.8	11.0	12.5	151	31.5										
	3	95	145	305	360	2.0	4.2	5.0	131	14.5	395	51	14	500	116			2.1	20	370
		142	137	298	353	2.2	4.7	5.6	151	16.0										
804	1	118	725	1305	1510	15.0	27.0	31.0	197	72.0	590	252	280	500	4.9		3.1	100		
		177				17.0	31.0	35.5	225	82.0										
	2	118	330	620	725	7.0	13.0	15.0	200	37.5	600	131	70	3000	600	23.2	0.6	3.1	45	130
		177				8.0	15.0	17.0	228	43.0										
	3	118	135	280	330	3.0	6.0	7.5	211	21.0	630	108	15	600	109			3.1	17.0	460
		177	128	273	323	3.3	6.5	8.5	241	23.0										
806	1	158	650	1170	1355	22.0	40.0	46.0	324	111	970	385	500	700	5.6		5.5	96.0		
		237				25.0	46.0	53.0	373	126										
	2	158	300	560	650	10.0	19.0	22.0	322	54	965	190	130	2600	700	23.0	0.8	5.5	44.5	180
		237				11.5	22.0	25.0	370	62										
	3	158	125	258	305	4.0	8.7	10.3	317	28	950	100	32	700	90.8			5.5	19.0	625
		237	119	252	299	4.5	10.0	11.5	369	31										
808	1	200	575	1030	1195	37.0	66.0	76.4	612	184	1835	640	700	700	4.2		11.1	91		
		300				42.5	76.0	88.0	706	210										
	2	200	265	495	575	17.0	32.0	37.0	614	89	1840	310	175	2300	700	17.8	1.0	11.1	42	225
		300				19.5	37.0	42.0	705	102										
	3	200	115	234	275	7.5	15.0	18.0	620	50	1860	175	44	700	71.6			11.1	18	860
		300	110	229	270	8.0	17.0	20.0	704	53										
810	1	250	550	990	1140	52.0	93.0	108.0	902	251	2700	880	860	650	4.0		16.5	88		
		375				60.0	107.0	124.0	1038	289										
	2	250	255	475	550	24.0	45.0	52.0	902	124	2700	435	215	2200	650	16.0	1.2	16.5	41	325
		375				27.5	52.0	60.0	1038	142										
	3	250	110	220	260	10.8	21.0	25.0	913	67	2740	235	54	650	65.0			16.5	17	1175
		375	106	216	256	11.5	24.0	28.0	1047	73										
812	1	355	515	925	1070	75.0	135.0	156.0	1392	366	4100	1280	1200	700	2.4		23.8	77.0		
		527				86.0	155.0	179.0	1597	419										
	2	355	240	445	515	35.0	65.0	75.0	1392	180	4180	630	300	1900	700	9.7	1.4	23.8	36.0	445
		527				44.0	75.0	86.0	1598	205										
	3	355	110	220	260	16.0	32.0	38.0	1391	100	4170	350	75	700	39.0			23.8	16.5	1575
		527	106	216	256	16.0	36.0	43.0	1605	112										
814	1	425	500	900	1045	112.0	202.0	234.0	2140	550	6420	1760	1500	700	0.6		34.3	76		
		640				129.0	232.0	269.0	2461	630										
	2	425	230	430	500	52.0	96.0	112.0	2143	270	6430	865	375	1700	700	2.5	1.5	34.3	35	600
		640				60.0	110.0	129.0	2465	310										
	3	425	105	213	251	24.0	48.0	57.0	2167	149	6500	475	95	700	7.5			34.3	15.5	2150
		640	101	209	247	26.5	54.0	65.0	2495	164										
816	1	570	480	865	1000	150.0	270.0	311.0	2978	724	8930	2320	1800	700	0.47		50.5	87.0		
		850				172.0	310.0	358.0	3420	830										
	2	570	222	413	480	69.0	129.0	150.0	2978	357	8930	1140	450	1600	700	1.9	1.7	50.5	40.0	820
		850				79.0	148.0	172.0	3414	408										
	3	570	97	194	228	30.0	60.0	71.0	2960	183	8880	585	110	700	7.8			50.5	18.0	2910
		850	93	190	224	33.0	67.0	80.0	3389	204										
		1140	91	188	222	35.0	72.0	86.0	3676	219										



FRAME	ARM REF	AIR QTY L/S	BASE SPEED RPM AT VOLTS			POWER KW AT			RATED TORQUE NM	RATED CURRENT AMPS	TORQUE MAX NM	CURRENT MAX AMPS	MAX COMM PRODUCT KA * RPM	MAX SPEED RPM	MAX VOL V	ARM CKT LmH	EX CN SUPPLY KW APPROX	INERTIA GD <sup>2</sup>	MECH TIME CONSTANT	ARM WEIGHT TOTAL
			230	400	460	230	400	460												
818	1	750	435	780	905	187.0	335.0	389.0	4103	900										
		1130				215.0	385.0	447.0	4716	1030	12310	2880	2000							
		1510				234.0	419.0	486.0	5131	1120										
	2	750				87.0	161.0	187.0	4116	445										
		1130	201	374	435	100.0	185.0	215.0	4731	511	12350	1420	500	1500	700		1.8	89.6	43	1025
		1510				107.0	201.0	234.0	5117	545										
	3	750	90	180	212	39.0	78.0	92.0	4140	230										
		1130	87	177	209	43.0	88.0	104.0	4739	253	12420	740	125							
		1510	84	174	206	46.0	94.0	111.0	5150	270										

NOTES: 1) 808 TO 818 DATA IS FOR FORCE VENT CONTINUOUS OR TENY 1 HOUR.  
 2) MAXIMUM COMM. PRODUCT DEFINES THE LIMIT OF SPEED OBTAINABLE BY FIELD WEAKENING AT ANY SPECIFIC LOAD. EXAMPLE: FOR FRAME 814 REQUIRED LOAD TORQUE 5000 NM. MAXIMUM MOTOR TORQUE 6420 NM. CURRENT REQUIRED FOR MAXIMUM TORQUE = 1760A, CURRENT REQUIRED FOR 5000 NM = 1370A.

$$\text{MAXIMUM PERMISSIBLE SPEED} = \frac{1500 * 10^3}{6D^2 * (KGM^2) * \text{SPEED (RPM)}} = 1094.8 = 1090 \text{ RPM}$$

$$\text{MECHANICAL TIME CONSTANT (MS)} = \frac{375 * \text{ACCELERATION TORQUE IN KGM}}{375 * 60.14} = 100 \text{ MILLI SECONDS}$$

EXAMPLE: FRAME 804

ARM. REF. 1 GD<sup>2</sup>=3.1 Kgm<sup>2</sup>, SPEED=725 RPM  
 MAX TORQUE = 510 NM (60.14 KGM)

$$\text{MECHANICAL TIME CONSTANT} = \frac{3.1 * 725}{375 * 60.14} = 100 \text{ MILLI SECONDS}$$

\* WEIGHT OF THE MACHINE INDICATED IS FOR IC 06 TYPE OF COOLING. \* TYPICAL di/dt 60 In/SEC.

### SOLID YOKE MOTOR NON SPLIT SHUNT WOUND COMPENSATED

FRAME	TOTALLY ENCLOSED		PROTECTED SELF VENTILATED				TORQUE nM	
	1 HR 75 kW	DEG RISE rpm	CONTINUOUS 75 DEG RISE kW rpm		1 HR 75 DEG RISE kW rpm		Rated	Maximum
620	205	390	205	390	261	390	5019/6390	14800
622	280	360	280	360	354	360	7427/9390	21900
624	373	340	373	340	466	340	10476/13088	30900



## Laminated Yoke Motors Type LMDC

TECHNICAL PARAMETERS OF LAMINATED YOKE MILL DUTY MOTORS FOR FULL, HALF & QUARTER SPEEDS. ALL MACHINES ARE NONSPLIT COMPENSATED SHUNT SEPARATELY EXCITED MACHINES. THESE PERFORMANCE FIGURES ARE FOR COOLING SUCH AS 17, 37, 06, 0666, W37A86. ARMATURE REF: 1: FULL SPEED; 2: HALF SPEED; 3: QUARTER SPEED. TYPICAL AND SUBJECT TO CONFIRMATION IN SPECIFIC CASES.

FRAME	ARM REF	AIR QTY L/S	BASE SPEED RPM			POWER kW AT			RATED TORQUE NM	RATED CURRENT A	TORQUE MAX NM	MAX COMM PRODUCT KA* RPM	MAX SPEED RPM	MAX VOL V	ARM CKT L/R mH/mDHMS	MAX I AMPS	EXEC SUPPLY kW	INERTIA GD²	MECH TIME CONSTANT	WEIGHT KG	
			230V	400V	460V	230V	400V	460V													
808	1	200	575	1030	1195	37.0	66.0	76.5	612	181	1835	700	2300	700	0.94	700	1.0	7.4	61	190 820 1.2.21.4	
		300				42.5	76.0	88.0	706	208					108						
		400				46.0	83.0	96.0	767	225											
	2	200	265	495	575	17.0	32.0	37.0	614	89	1840	175	2300	700	2.5	175	1.0	7.4	28		
		300				19.5	37.0	42.0	705	102					375						
		400				21.0	40.0	46.0	764	110											
	3	200	115	234	275	7.5	15.0	18.0	620	50	1860	44	2300	700	11	44	1.0	7.4	12		
		300	110	229	270	8.0	17.0	20.0	704	53					600						
		400	107	226	267	8.5	18.0	22.0	769	56											
810	1	250	550	990	1140	52.0	93.0	108.0	902	252	2700	860	2200	650	0.56	860	1.2	11.7	63		
		375				60.0	107.0	124.0	1038	293					84						
		400				65.0	116.0	135.0	1126	317											
	2	250	255	475	550	24.0	45.0	52.0	913	124	2700	215	2200	650	2.1	215	1.2	11.7	29		
		375				27.5	52.0	60.0	1038	142					325						
		400				30.0	56.0	65.0	1126	154											
	3	250	110	220	260	10.5	21.0	25.0	913	70	2740	54	2200	650	10.6	54	1.2	11.7	12		
		375	106	216	256	11.5	24.0	28.0	1047	77					1140						
		400	103	213	253	12.0	25.0	30.0	1122	80											
812	1	355	575	925	1070	75.0	135.0	156.0	1392	366	4180	1200	1900	700	0.38	1280	1.4	18.9	61		
		527				86.0	155.0	179.0	1597	420					32.0						
		710				94.0	169.0	195.0	1742	459											
	2	355	240	445	515	35.0	65.0	75.0	1392	180	4180	300	1900	700	1.45	630	1.4	18.9	29		
		527				40.0	75.0	86.0	1598	209					160						
		710				44.0	81.0	91.0	1725	230											
	3	355	110	220	260	16.0	32.0	38.0	1391	105	4170	75	1900	700	7.8	350	1.4	18.9	13		
		527	106	216	258	18.0	36.0	43.0	1605	118					700						
		710	103	213	253	19.0	39.0	48.0	1774	124											
814	1	425	500	900	1045	112.0	202.0	234.0	2140	550	6420	1500	2200	700	0.6	1760	1.5	34.3	76		
		640				129.0	232.0	269.0	2461	630					20						
		850				140.0	253.0	293.0	2678	682					2.5						
	2	425	230	430	500	52.0	96.0	112.0	2143	270	6430	375	1700	700	109	86.5	1.5	34.3	35		
		640				60.0	110.0	129.0	2465	310					7.5						
		850				65.0	120.0	140.0	2679	335											
	3	425	105	213	251	24.0	48.0	57.0	2167	149	6500	95	2200	700	413	475	1.5	34.3	15.5		
		640	101	209	247	26.5	54.0	65.0	2495	164											
		850	98	206	244	28.0	58.0	70.0	2718	173											
816	1	570	480	865	1000	150.0	270.0	311.0	2978	724	8930	1800	2200	700	0.47	2320	1.7	50.5	87		
		850				172.0	310.0	358.0	3420	830					13						
		1140				187.0	337.0	389.0	3718	900					1.9						
	2	570	222	413	480	69.0	129.0	150.0	2978	357	8930	450	1600	700	68	1140	1.7	50.5	40.0		
		850				79.0	148.0	172.0	3414	408					7.8						
		1140				86.0	161.0	187.0	3714	444											
	3	570	97	194	228	30.0	60.0	71.0	2960	183	8880	110	2200	700	340	585	1.8	50.5	18.0		
		850	93	190	224	33.0	67.0	80.0	3389	204											
		1140	91	188	222	35.0	72.0	86.0	3676	219											
818	1	750	435	780	905	187.0	335.0	389.0	4103	900	12310	2000	2200	700	0.32	2880	1.8	89.6	94		
		1130				215.0	385.0	447.0	4716	1030					10						
		1510				234.0	419.0	486.0	5131	1120											
	2	750	201	374	435	87.0	161.0	187.0	4116	445	12350	500	1500	700	1.2	1420	1.8	89.6	43		
		1130				100.0	185.0	215.0	4731	511					50						
		1510				107.0	201.0	234.0	5117	545											
	3	750	90	180	212	39.0	78.0	92.0	4140	230	12420	125	2200	700	4.7	740	1.8	89.6	19		
		1130	87	177	209	43.0	88.0	104.0	4739	253											
		1510	84	174	206	46.0	94.0	111.0	5150	270											

- NOTES: 1) 808 TO 818 DATA IS FOR FORCE VENT CONTINUOUS OR TENV 1 HOUR.  
 2) MAXIMUM COMM. PRODUCT DEFINES THE LIMIT OF SPEED OBTAINABLE BY FIELD WEAKENING AT ANY SPECIFIC LOAD.  
 3) WEIGHT OF THE MACHINE INDICATED IS FOR IC 06 TYPE OF COOLING.  
 4) TYPICAL di/dt 250 1n/SEC.

### Ratings for Solid Yoke / Laminated Yoke Motors with IC06 construction

LAMINATED YOKE MOTORS WITH IC 06 CONSTRUCTION AND TEMP RISE LIMITED TO 110 DEG K OVER 40 DEG CEN AMBIENT

FRAME	KW	SPEED rpm	RATED CURRENT Amps	MAX CURRENT Amps	RATED TORQUE Kg.m²	MAX MECH SAFE SPEED rpm	ARMATURE CIRCUIT INDUCTANCE/RESISTANCE mH/DHMS
820	596.8	800	1350	2700	7124	1500	0.35/0.0115
822	780	740	1760	3600	10065	1500	0.37/0.0124
824	970	700	2200	4500	13230	1360	0.27/0.0084

\* Rated current is for an armature voltage of 475 V.



## Ratings for Motors with IC 0041 construction

TYPICAL OUTPUT AND SPEEDS FOR IC 0041 ; TOTALLY ENCLOSED NON VENTILATED MOTORS , CONTINUOUS DUTY  
WITH TEMP RISE LIMITED TO 110 DEG K OVER 40 DEG AMBIENT

KMDC	FULL SPEED		HALF SPEED		QUARTER SPEED	
	230 V kW/rpm	460 V kW/rpm	230 V kW/rpm	460 V kW/rpm	230 V kW/rpm	460 V kW/rpm
802	5.0/900	11/900	2.6/470	6.0/998	1.0/200	2.5/462
803	6.3/800	13/1665	3.4/420	7.5/882	1.35/170	3.3/383
804	7.5/725	17/1504	4.5/375	10/787	1.9/160	4.0/335
806	10/650	22/1350	6.3/345	13/723	2.6/160	5.5/346
808	15/575	33/1200	9.0/315	18.5/655	3.7/145	8.0/313
810	18.5/550	40/1140	12/300	22/620	4.8/135	10/286
812	22.5/515	45/1067	15/285	25/586	6.7/130	12.5/273
814	30/500	55/1034	20/265	37/545	9.7/125	18.5/261



**EN 29001/ISO 9001/BS 5750**  
APPROVED BY BVQI



**EN 29001/ISO 9001/BS 5750**  
APPROVED BY BVQI

Our Quality Systems For DC Machines Confirm To ISO 9001 Requirements

The design and manufacture of our products are subject to constant improvement. Hence, the above specifications and illustrations may vary slightly from the product supplied.

ENQUIRIES MAY BE DIRECTED TO THE MARKETING DEPARTMENT AT UNIT III.

## KIRLOSKAR ELECTRIC

Regd. Office: Industrial Suburb, Rajajinagar, Bangalore-560 010.

Manufactured at:

Unit III: P.B. No. 5804, Peenya Industrial Area, Phase II, Bangalore-560 058.

Tel: 080-8394961 Tlx: 0845-5016